

# Spectrophotometer

 MYIRO-1

## **En** Instruction Manual



Please read before using the instrument.

Scan the 2D code to access the most recent instruction manual.



# Safety Symbols

The following symbols are used in this manual to prevent accidents that may occur because of incorrect use of the instrument.



**Denotes an instruction regarding a safety warning or note.**  
**Read the instruction carefully to ensure safe and correct use.**



**Denotes a prohibited operation.**  
**This operation must never be performed.**



**Denotes an instruction.**  
**This instruction must be strictly adhered to.**



**Denotes a prohibited operation.**  
**Never disassemble the instrument.**



**Denotes an instruction.**  
**To turn the power OFF, unplug the USB cable from the connected device.**



**Denotes a warning about the LED.**  
**Read the instruction carefully to ensure safe and correct use.**

## **Notes on this Manual**

- Copying or reproduction of all or part of the contents of this manual without the permission of THE MANUFACTURER OF THIS PRODUCT is strictly prohibited.
- The contents of this manual are subject to change without prior notice.
- Every effort has been made in the preparation of this manual to ensure the accuracy of its contents. However, should you have any questions or find any errors, please contact your retailer.
- THE MANUFACTURER OF THIS PRODUCT will not accept any responsibility for consequences arising from the use of the instrument.

# Safety Precautions

To ensure correct use of this instrument, read the following points carefully and adhere to them. After you have read this manual, keep it in a safe place where it can be referred to anytime a question arises.



**WARNING** (Failure to adhere to the following points may result in death or serious injury.)



Do not use the instrument in places where flammable or combustible gases (gasoline, etc.) are present. Doing so may cause a fire.

---



Do not disassemble or modify the instrument. Doing so may cause a fire or electric shock.

---



Do not allow liquid or metal objects to enter the instrument. Doing so may cause a fire. Should liquid or metal objects enter the instrument, turn the power OFF immediately, disconnect the USB cable and contact your retailer.

---



Do not forcibly bend, twist, or pull the USB cable. Also, do not scratch, fabricate, or place heavy objects on the USB cable. Doing so may damage the USB cable and cause a fire or electric shock.

---



The instrument should not be operated if it is damaged, or if smoke or odd smells occur. Doing so may cause a fire. If smoke, odd smells, or damage occurs, turn the power OFF immediately, disconnect the USB cable from the connected device, and contact your retailer.

---



Always hold the USB cable plug itself when disconnecting the USB cable. Pulling on the cable may damage it and cause a fire or electric shock.

---



Do not insert or disconnect the USB cable with wet hands. Doing so may cause electric shock.

---



**WARNING** (Failure to adhere to the following points may result in death or serious injury.)



If the instrument will not be used for a long time, disconnect the USB cable. Accumulated dirt or water on the USB cable connector may cause a fire. Clean off any dirt or water on the USB cable connector before use.

---



Firmly push the USB cable completely into the socket. Incomplete insertion may cause a fire or electric shock.

---



If the instrument is found to be leaking or emitting an unusual odor, keep the instrument away from any open flames. The electrolytic solution from the battery may catch fire, causing rupture or fire.

---



Do not place lenses, reflective objects, or optical elements in the path of the UV-LED. Doing so may cause the light from the LED to become concentrated, which may cause injury to the eyes or burning. In addition, the back of the object should be blocked by a wall or other object capable of blocking the LED, thus preventing the above from happening inadvertently.

---



Do not look directly into the LED light (including the beam, marker, and projection window). Doing so may injure the eyes.

---



Be sure to turn the instrument OFF in areas where use is prohibited, such as in airplanes or hospitals. Using the instrument in such areas may affect the electronics and medical equipment, which may cause an accident.

---



**CAUTION** (Failure to adhere to the following points may result in injury or damage to the instrument or other property.)



Take care not to pinch yourself on the areas of the instrument that open and close. Doing so may result in injury.

---



Do not use the instrument if the limiting aperture (measuring port) is in the line of sight. Doing so may result in injury to the eye.

---

# Table of Contents

Safety Symbols .....	i
Notes on this Manual .....	ii
Safety Precautions .....	1
Introduction .....	5
Notes on Use .....	5
Standard Accessories.....	10
Optional Accessories .....	11
System Diagram .....	12
Names and Functions of Parts .....	13
Charging .....	15
Connecting to a Computer.....	16
Turning the Power ON/OFF .....	17
Calibration .....	18
Calibration Method.....	19
Measurement .....	20
Scan Measurement.....	20
Spot Measurement .....	22
Display Measurement (Brightness Measurement).....	23
Ambient Light Measurement .....	23
Cleaning the Protection Glass .....	24
Storage Method.....	26
Troubleshooting .....	27
Specifications .....	29
Dimensions .....	32

# Introduction

The MYIRO-1 is a compact, lightweight hand-held spectrophotometer designed for measuring color and density in the printing and digital imaging industries with just one device.

## **Packing materials of the product**

Be sure to keep all packing materials used for shipping the product (cardboard box, cushioning material, plastic bags, etc.). This instrument is a precision measuring instrument. When transporting the instrument to a service facility for maintenance or for other reasons, be sure to use the packing materials to minimize shock or vibration. If the packing materials are lost or damaged, contact your retailer.

## Notes on Use

### **Operating Environment**

- Use the instrument at an ambient temperature of between 10°C and 35°C and a relative humidity of between 30% and 85% with no condensation.
- Be sure to use the instrument within this range. Do not use it in areas of rapid temperature changes.
- Do not leave the instrument in direct sunlight or near heat sources such as a stove. Doing so may cause the internal temperature of the instrument to become much higher than the ambient temperature.
- Do not use the instrument in areas where dust, cigarette smoke, or chemical gases are present. Doing so may cause deterioration in performance or a malfunction.
- Do not use the instrument near equipment that produces a strong magnetic field (such as speakers).
- The instrument is a pollution level 2 product (equipment that may cause temporary electrical hazards due to contamination or condensation or products that are used in such an environment).
- Do not use the instrument at altitudes higher than 2,000 m.
- This instrument has been designed exclusively for indoor use. It should never be used outdoors because rain or other factors may damage the instrument.



## Measurement

- Make sure no dust gets into the instrument ports.
- When not using the instrument for a long period of time, remove the limiting aperture, and blow off dirt or dust on the protection glass with a blower before use.
- Over extended periods of use, changes in the surrounding environment may result in the measured values shifting. Performing calibration periodically is recommended to ensure measurements are accurate.

## White Calibration Plate

- Make sure the white calibration plate being used includes the same serial number as that of the instrument being used.
- The calibration data for the white calibration plate was measured at 23°C.
- To achieve the highest accuracy when measuring absolute values (colorimetric values), calibration and measurement should be performed at 23°C.
- Do not allow the white calibration plate to become scratched or dirty.
- When the calibration cap is not in use, keep the white calibration plate away from external light and dust.

## Ruler

- The sliding surface has a special coating that facilitates sliding. If there is dust or dirt on the ruler, use a blower to blow it off or gently wipe it with a soft, clean dry cloth. Never use solvents such as thinner or naphtha.

## **Ambient Light Adapter**

- Make sure the ambient light adapter being used includes the same pairing number as that of the instrument being used.
- Do not allow the ambient light adapter to become scratched or dirty.
- Keep the ambient light adapter away from external light and dust when not in use.

## **Power Source**

- When the instrument is not being used, turn the power switch OFF.
- To charge the instrument, connect it to a computer using the USB cable.

## **System**

- Do not subject the instrument to strong vibrations or impacts. Doing so may cause deterioration in performance or a malfunction.
- The limiting aperture (measuring port) of this instrument is a particularly precise component of the optical system. Do not allow the aperture to become dirty or subject the aperture to impacts. When the instrument is not in use, make sure to attach the calibration cap to protect the limiting aperture (measuring port).
- The instrument may cause interference if used near a television, radio, transceivers, etc.
- Communication with connected external devices may be interrupted if the instrument is exposed to strong external static electricity. In such cases, turn the power OFF and then ON again.
- When turning the power OFF and then ON again, wait several seconds after turning the power OFF before turning the power back ON.

## Internal Lithium-Ion Battery

- The battery is not charged upon purchase and must therefore be charged.
- The battery will be charged from power supplied through the USB cable regardless of whether the instrument is turned ON or OFF.
- Charging should be performed at between 5°C and 40°C.
- The internal lithium-ion battery takes about 3 hours to become fully charged. There is no need to worry about overcharging.
- The lithium-ion battery will self-discharge. The battery will become unusable due to over discharging if left for a long period. Charge the battery at least once every 6 months.

## Notes on Storage

- The instrument should be stored at a temperature of between 0°C and 45°C and a relative humidity of between 0% and 85% with no condensation. Do not store the instrument in areas subject to high temperatures, high humidity, or sudden changes in temperature, or in areas where freezing or condensation may occur, as these circumstances may cause a malfunction. We recommended storing the instrument with a drying agent at a temperature of around 20°C.
- Do not leave the instrument inside a vehicle, such as in the cabin or the trunk. Otherwise, the temperature and/or humidity may exceed the allowable range for storage during midsummer or midwinter, resulting in a malfunction.
- Do not store the instrument in areas where dust, cigarette smoke, or chemical gases are present. Doing so may cause deterioration in performance or a malfunction.
- Dust inside the limiting aperture (measuring port) may prevent accurate measurements from being performed. When the instrument is not in use, attach the calibration cap, and store the instrument in the standard accessory soft case.
- The white calibration plate and ambient light adapter may become discolored if left exposed to light. Therefore, make sure to store the components in a location away from direct exposure to light when not in use.
- If the instrument will not be used for a long period of time, an auxiliary charge is recommended once a year to protect the battery from overdischarge.

## **Notes on Transporting**

- When transporting the instrument, be sure to use the packing materials to minimize shock or vibration.
- When sending the instrument to your retailer, package and send the instrument and all accessories.

## **Maintenance and Inspection**

- To maintain measurement accuracy, the instrument should be inspected once a year. For information on inspection, contact your retailer.

## **Notes on Cleaning**

- When the instrument is dirty, wipe it with a soft, clean dry cloth. Never use solvents such as thinner or naphtha.
- If the white calibration plate becomes dirty, wipe it with a soft, clean dry cloth. If the dirt is difficult to remove, wipe it off with a cloth dampened with commercially available lens cleaning solution, remove the solution with a cloth dampened with water, and allow the plate to dry before using.
- Should the instrument break down, do not try to disassemble or repair it by yourself. Contact your retailer.

## **Disposal Method**

- Make sure that the instrument, its accessories, and the packing materials are either disposed of or recycled correctly in accordance with local laws and regulations.

# Standard Accessories

## Calibration Cap MY-A01

Used to perform white calibration and zero calibration.

The calibration cap can be stored on the main body during measurement.

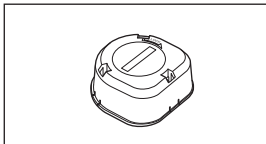

## Ruler MY-A02

Used to perform spot measurement or scan measurement.

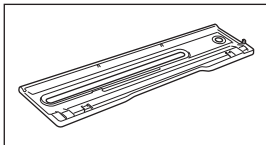

## USB Cable IF-A41

Used to connect the instrument to a computer.

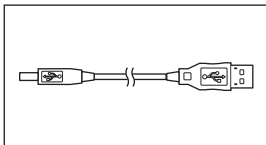

## Soft Case MY-A03

Used to store the instrument together with the included accessories.

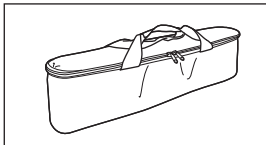

## Spectrophotometer ConfigurationTool MY-CT1

Used to configure network settings and write calibration values to the instrument. Visit the following website to download the tool.

<https://www.myiro.com/downloads>

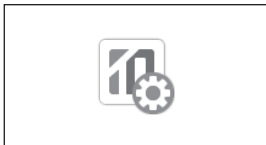

# Optional Accessories

## **Ambient Light Adapter MY-A04**

Used to perform ambient light measurement.

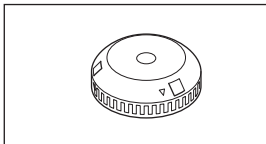

# System Diagram

## Standard Accessories



Spectrophotometer Configuration Tool

**MY-CT1**

\*Available for download on the Web

Main body

**MY-1**

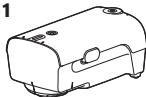

USB cable

**IF-A41**

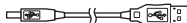

Calibration cap

**MY-A01**

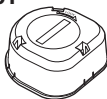

Ruler

**MY-A02**

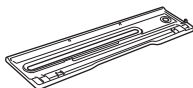

Soft case

**MY-A03**



Computer  
(commercially  
available)



Tripod for display  
measurement  
(commercially  
available)

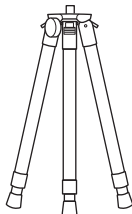

## Optional Accessories

Ambient light adapter

**MY-A04**





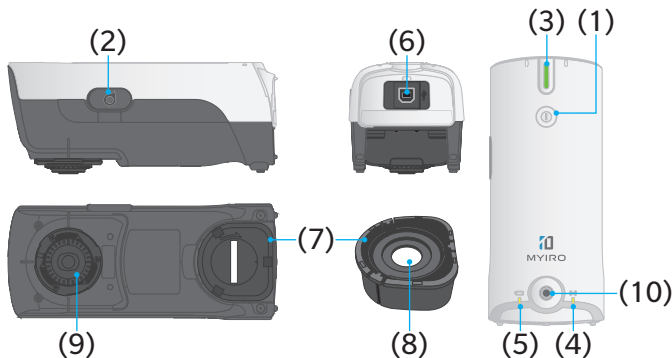







# Names and Functions of Parts







- |   |  |
|---|--|
| <b>(1) Power button</b>                       | Turns the instrument power ON or OFF. The instrument switches between ON/OFF every time the power button is pressed.   |
| <b>(2) Measurement button</b>                 | Used to perform measurement.   |
| <b>(3) Status indicator</b>                   | Displays the instrument status. The indicator flashes a different color according to the status, such as "Measurement possible", "Scan successful/failure", and "Error". |
| <b>(4) Wireless LAN indicator</b>             | Displays colors and illumination patterns (lit/flashing) to show the wireless LAN connection status.   |
| <b>(5) Battery indicator</b>                  | Displays the remaining battery power and charging status through flashing or being lit.  |
| <b>(6) USB connection terminal</b>            | Used to connect the instrument to a computer via the USB cable. In addition to enabling communication with a computer, the terminal is also used for charging.           |
| <b>(7) Calibration cap</b>                    | Attached to the limiting aperture during calibration and for storage.  |
| <b>(8) White calibration plate</b>            | Used to calibrate the instrument.  |
| <b>(9) Limiting aperture (measuring port)</b> | This is the aperture for measuring samples. The aperture can be removed when cleaning the protection glass.  |
| <b>(10) Tripod mount screw</b>                | Used for securing the instrument to a commercially available tripod. Tripod mounting is used for measuring displays.   |



The status indicator colors and their relevant statuses are as follows.

Indicator		Status	Meaning
Not lit		Power OFF	The instrument power is not turned ON.
Lit orange		Power ON	No software is connected.
Lit yellow		Calibration not performed	Calibration has not been performed.
Lit blue		Measurement possible	Measurement can be performed.
Lit white		Measuring	Measurement is in progress.
Lit green (1 s)		Measurement successful	Measurement was performed correctly.
Flashing red (1 s)		Measurement failed	Measurement was not performed correctly.
Flashing light blue		Calibrating	Calibration is currently being performed.
Lit green (1 s)		Calibration successful	Calibration was performed correctly.
Flashing red (1 s)		Calibration failed	Calibration was not performed correctly.

The wireless LAN indicator colors and their relevant statuses are as follows.

Indicator		Status	Meaning
Not lit		Not connected	Connection to the access point has not been established. Alternatively, a USB connection has been established.
Flashing orange		Attempting to connect to access point	Connection to the access point is currently being established.
Flashing red (1 s)		Access point connection failed	Connection to the access point could not be established.
Lit orange		Access point connection successful	Connection to the access point has been established.
Lit blue		Connection via wireless LAN	Connection via wireless LAN has been established.

# Charging

This instrument is powered by an internal lithium-ion battery. To charge the internal lithium-ion battery, connect the instrument to a computer via the USB cable.

## Operating Procedure

- 1 Connect the connector of the USB cable to the USB connection terminal on the instrument.**
- 2 Connect the other connector of the USB cable to the USB terminal on the computer.**

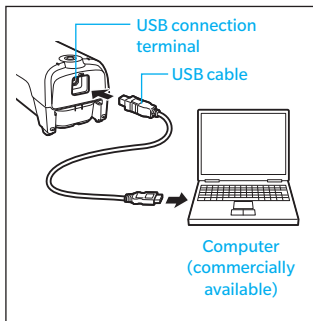

The battery indicator displays the remaining power and charge status of the internal lithium-ion battery.



Indicator	Status	Meaning
Not lit	Remaining battery power available	The internal lithium-ion battery has sufficient power to operate the instrument.
Flashing orange	Low battery	The remaining battery power is low. Please charge.
Lit orange	Charging	The instrument is currently being charged.

# Connecting to a Computer

This instrument is equipped with a USB connection terminal and a wireless LAN connection function.

## Operating Procedure

### 1 Connect the instrument to the computer.

#### Connecting via USB

Connect the included USB cable to the USB connection terminals on the instrument and on the computer.

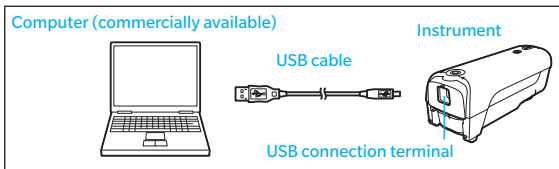

#### Connecting via wireless LAN

Configure the network settings on the instrument using the Spectrophotometer Configuration Tool.

The Spectrophotometer Configuration Tool can be downloaded from the following website.

<https://www.myiro.com/downloads>

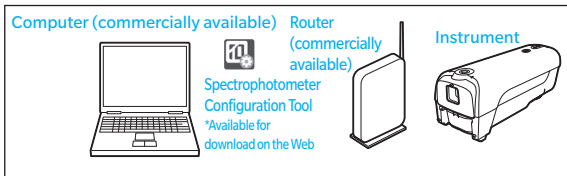

**Memo** For how to configure the network settings for the instrument, refer to Spectrophotometer Configuration Tool instruction manual.

**Memo** This instrument is compatible with WPA2-PSK (WPA2-Personal).

### 2 Turn the instrument power ON (see page 17).

**CAUTION** It is best to turn ON the instrument before starting any software.

# Turning the Power ON/OFF

## Operating Procedure

- 1 Press the power button.**  
The status indicator will be lit, and the power will turn ON.

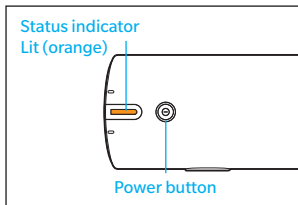

- 2 Press the power button again.**  
The status indicator will turn OFF, and the power will turn OFF.

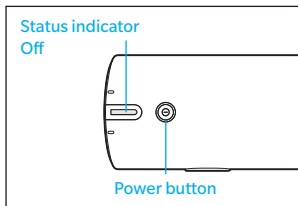

### **Auto Power Off function (Initial setting: 15 minutes)**

This instrument is equipped with an Auto Power Off function that automatically turns the power OFF if the device is not operated after a specified time. To turn the power back ON, press the power button. When this occurs, the calibration data will be erased, so recalibration will be necessary. The Auto Power Off function is disabled when the instrument is connected to a computer via a USB cable.

You can change the time using the Spectrophotometer Configuration Tool. The Spectrophotometer Configuration Tool can be downloaded from the following website.

<https://www.mylro.com/downloads>

# Calibration

## Calibration must be performed before measurement.

**CAUTION**

Calibration cannot be performed using just the instrument. Connect the instrument to the PC beforehand, and start up the software.

## Calibration

This instrument requires calibration before performing measurement after the power is turned ON or if a certain amount of time has passed since the previous calibration.

Calibration must also be performed after cleaning the white calibration plate or the protection glass.

**Memo**

The reading may fluctuate slightly due to changes in the ambient temperature or due to heat generation caused by repeated operation of the instrument. In such cases, perform calibration regularly.

## Calibration cap serial number

Serial numbers are included on both the instrument and the calibration cap. Make sure the calibration cap being used includes the same serial number as that of the instrument being used.

**Memo**

If the calibration cap was purchased as an optional accessory for replacement, attach the included pairing number stickers to both the instrument and the calibration cap, write the calibration data to the instrument, and use the cap only for the instrument with the same pairing number.

**Memo**

To write calibration data to the instrument, use the Spectrophotometer Configuration Tool available for download from the following website.  
<https://www.myiro.com/downloads>

## Temperature conditions during calibration

Calibration must be performed at the same temperature at which measurement will be performed.

**Memo**

Perform calibration after the instrument and the white calibration plate have had enough time to adapt to the ambient temperature.

# Calibration Method

## Operating Procedure

- 1 Attach the calibration cap to the limiting aperture.**

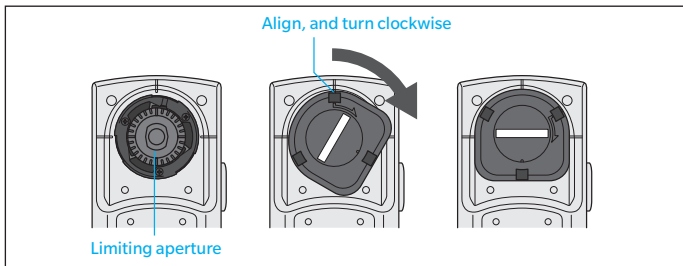

- 2 Wait for the status indicator to light up yellow, and then press the measurement button. Calibration will be performed.**

**Memo** The calibration result will be indicated by the color and illumination patterns (lit/flashing) of the status indicator following calibration. (See page 14)

**CAUTION** If the status indicator lights up blue, calibration will not be possible even if the measurement button is pressed. Perform calibration from the software being used.

**Memo** The calibration cap can be stored on the instrument during measurement.

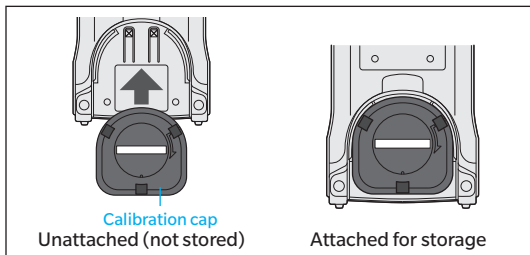

# Measurement

The instrument can be used to perform the following measurements.

**CAUTION**

Software is required to perform measurement. For details on the measurement procedure, refer to the instruction manual for the software being used.

Be sure to perform calibration before starting measurement. (See pages 18 to 19)

## Scan Measurement

Use the ruler included as a standard accessory.

- 1 Set the ruler on the chart so that the  $\Delta$  mark on the ruler is at the end of the chart.**

The scan operation should start from the white part of the paper.

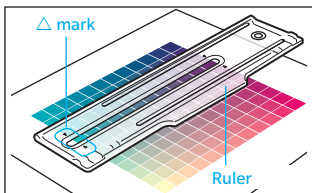

- 2 Place the instrument so that the two feet are aligned with the groove on the ruler, and then align the limiting aperture with the open end of the ruler.**

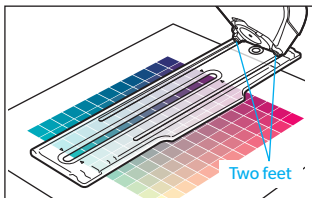

- 3 Press the measurement button.**

Verify that the status indicator changes from blue to white.

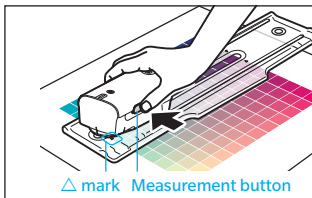

- 4** Slide the instrument while pressing the measurement button. Slide the instrument at a constant speed, moving from one end of the ruler to the other in 3 to 5 seconds.

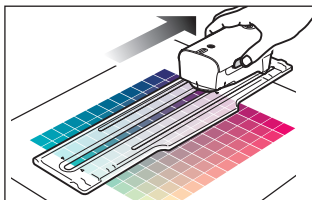

- 5** Release the measurement button when the instrument reaches the white part of the paper on the opposite side of the test chart.

**Memo**

The measurement result will be indicated by the color and illumination patterns (lit/flashing) of the status indicator following measurement. (See page 14)

Status indicator

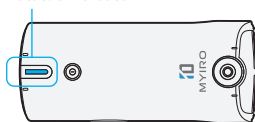



## Spot Measurement

Use the ruler included as a standard accessory.

- 1 Align the spot target on the ruler with the location to be measured.**

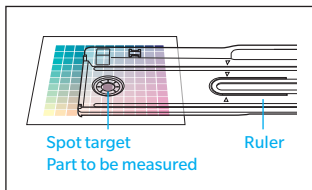

- 2 Place the instrument so that the limiting aperture is aligned with the spot target.**

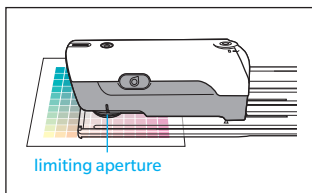

- 3 Press the measurement button.**

**Memo**

The status indicator will light up white during measurement and turn green if the measurement is performed successfully. The indicator will turn blue when the instrument is ready to perform the next measurement.

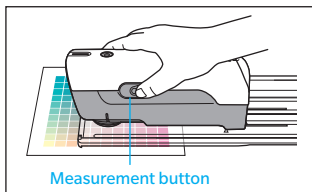

## Display Measurement (Brightness Measurement)

Use of a commercially available tripod or other device is recommended to ensure the instrument is stabilized during measurement.

Set the instrument so that the limiting aperture faces toward the display at a distance of 5 to 30 mm.

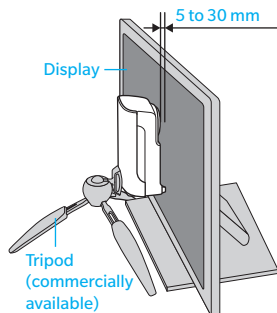

## Ambient Light Measurement

Use the optional ambient light adapter for measurement.

Attach the ambient light adapter to the limiting aperture to measure ambient light.

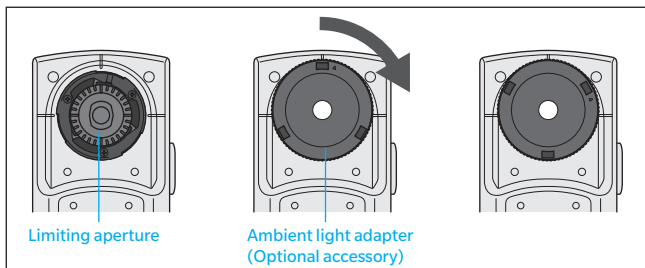

### CAUTION

Write the ambient light adapter value to the instrument using the Color Management Software MYIROtools in advance.

The Color Management Software MYIROtools can be downloaded from the following website. (<https://www.myiro.com/downloads>)

### CAUTION

This measurement does not conform to JIS C 1609:2006. Use it as a simple illuminance measurement function.

# Cleaning the Protection Glass

Clean the protection glass regularly to maintain accurate measurement results.

**CAUTION**

Wipe the glass with a soft, clean dry cloth. Never use solvents such as thinner or naphtha.

## Operating Procedure

### 1 Remove the limiting aperture.

While pressing down on the ribbed rim of the attached accessory (limiting aperture), rotate counterclockwise until the accessory stops.

Taking care to prevent the limiting aperture from dropping, flip the instrument over, and take the limiting aperture in your hand.

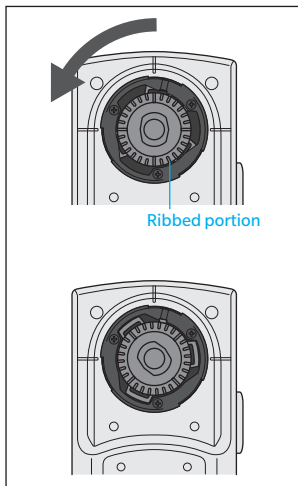

### 2 Clean the protection glass.

If there is dust or dirt on the glass, use a blower to blow it off or gently wipe it with a soft, clean dry cloth.

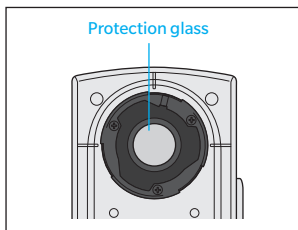

### 3 Attach the limiting aperture.

Align the protrusion on the limiting aperture with the indication on the frame, and press the aperture into the frame.

While pressing on the ribbed rim of the limiting aperture, rotate clockwise until a click is heard. Installation is correct if the four long ribs on the limiting aperture align vertically and horizontally with the instrument.

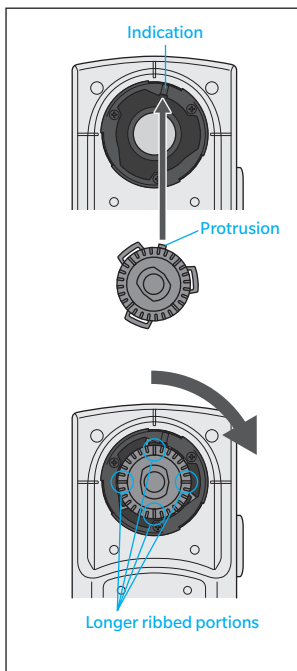

# Storage Method

Place the instrument inside the soft case for storage. Attach the calibration cap to the limiting aperture on the instrument. (See "1" on page 19)

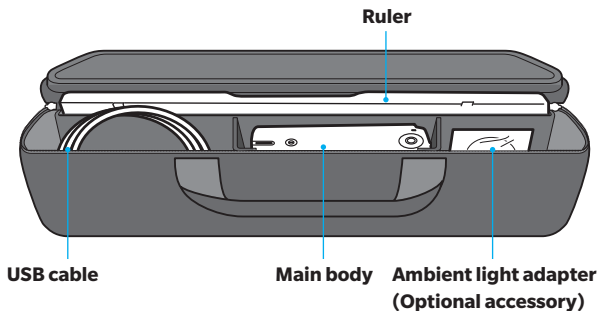

# Troubleshooting

If an abnormality has occurred with the instrument, take the necessary actions as given in the table below. If the symptom remains, contact your retailer.

Symptom	Check point	Action
The indicator does not light up.	Are the batteries dead?	Charge using USB bus power. The battery indicator may not light up for a few minutes during charging if the battery is heavily drained. If the battery indicator does not light up even after charging for a while, the instrument may be malfunctioning. Immediately stop using the instrument and contact your retailer.
Measurement results are abnormal.	Is the instrument pressed flush against the measurement specimen?	Make sure that the instrument is pressed flush against the specimen.
	Is the calibration cap correct?	Read the Calibration and Calibration Method sections carefully to ensure calibration is being performed correctly.
	Was calibration performed correctly?	
The instrument does not respond to commands from the computer. Commands cannot be accepted correctly.	Is the USB cable connected correctly?	Properly connect the instrument's USB connecting terminal to the computer's USB terminal with the USB cable supplied with the instrument.
	Is the USB cable supplied with the instrument being used?	
The power turns OFF suddenly even though the battery is charged.	Has the internal battery been recharged approximately 500 times?	Contact your retailer.

Symptom	Check point	Action
A wireless connection cannot be established. (The wireless LAN indicator does not light up.)	Is wireless LAN enabled on the instrument? (Wireless LAN is disabled when shipped from the factory.)	Use the Spectrophotometer Configuration Tool to enable wireless LAN on the instrument.
Connection to a wireless access point fails. (The wireless LAN indicator flashes red.)	Are the wireless access point settings configured correctly on the instrument?	Use the Spectrophotometer Configuration Tool to configure the wireless access point settings on the instrument correctly.
	Is the instrument being used in an environment with poor or unstable wireless radio signal conditions?	Use the instrument in an environment with a good wireless radio signal.
The instrument cannot connect to the wireless LAN. (The wireless LAN indicator does not change from orange to blue.)	Is the IP address set on the instrument on the same segment as the IP address of the wireless access point?	Use the Spectrophotometer Configuration Tool to set the IP address of the instrument to the same segment as the IP address for the wireless access point.

# Specifications

	Spectrophotometer MYIRO-1
<b>Model</b>	MY-1
<b>Illumination/viewing system</b>	45°a: 0°(annular illumination)*1 Conforms to CIE No. 15, ISO 13655, DIN 5033 Teil 7, ASTM E 1164, and JIS Z 8722 Condition a for reflectance measurements.
<b>Spectral separation device</b>	Concave grating
<b>Wavelength range</b>	Spectral reflectance: 380 to 730 nm; Spectral irradiance: 360 to 730 nm
<b>Wavelength pitch</b>	10 nm
<b>Half bandwidth</b>	Approx. 10 nm
<b>Measurement area</b>	Φ3.5 mm
<b>Light source</b>	LED
<b>Measurement range</b>	Density: 0.0D to 2.5D; Reflectance: 0 to 150%
<b>Repeatability</b>	Colorimetric: Within $\sigma \Delta E_{00}$ 0.05 (When white plate is measured 30 times at 10-second intervals after white calibration has been performed)
<b>Inter-instrument agreement</b>	Within $\Delta E_{00}$ 0.3 (Average of 12 BCRA Series II color tiles compared to values measured with a master body under manufacturer's standard conditions)
<b>Measurement time (single-point measurement)</b>	Approx. 1s
<b>Measurement conditions*2</b>	M0 (CIE Illuminant A), M1 (CIE Illuminant D50), M2 (illumination with UV-cut), User-defined illuminant
<b>Observers</b>	2° or 10° Standard Observer
<b>Status indicator</b>	LED to indicate instrument status
<b>Interface</b>	Wireless LAN (IEEE 802.11 b/g/n)*3 USB2.0
<b>Scanning measurements</b>	Scanning measurement of a color chart can be performed. (Values under all illumination conditions can be obtained with single scan)
<b>Power</b>	USB bus power; Rechargeable internal battery
<b>Dimensions (W×D×H)</b>	73 mm × 171 mm × 71 mm
<b>Weight</b>	Approx. 340 g
<b>Operating temperature / humidity range</b>	10 to 35°C, 30 to 85% relative humidity with no condensation
<b>Storage temperature / humidity range</b>	0 to 45°C, 0 to 85% relative humidity with no condensation

\*1 Illumination for wavelengths under 400 nm is unidirectional.

\*2 M0, M1, M2: Illumination conditions defined in ISO 13655 4.2.2 Illumination requirements and measurement

\*3 Compatible with WPA2-PSK (WPA2-Personal).



## Chart Specifications

	Item	Specifications	Remarks
Chart	Valid scan range	270 mm	
	Maximum chart width (Valid measurement range)	257 mm	The scan operation should start from the white part of the paper and end on the white part of the paper.
	Paper color	Not specified	The color difference between the end patches must satisfy $\Delta E^*ab > 10$ .

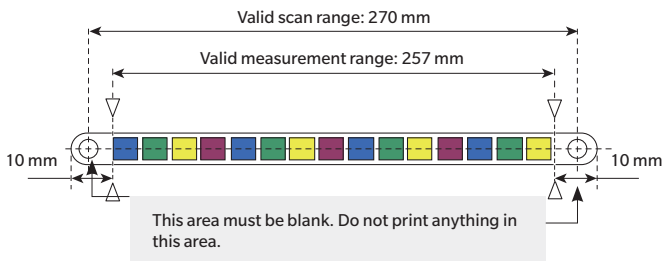

	Item	Specifications	Remarks
Patch	Scan direction	7 mm or more	The scan operation should start from the white part of the paper and end on the white part of the paper.
	Orthogonal direction	7 mm or more	
	Patch color difference	$\Delta E^*ab > 10$	If the difference between colors is small, insert a gap between the patches.

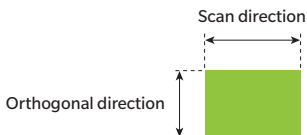

Item	Specifications	Remarks	
Gap	Gap conditions	One or two black or white lines	
	Gap and patch color difference	Color difference with single patch: $\Delta E^*ab > 20$	Color difference is not specified when using two white lines or two black lines.
	Gap width	0.5 to 1.0 mm	



## Scan Conditions

Item	Specifications	Remarks
Scan speed	Patch width: 7 mm	54 to 154 mm/s
	Patch width: 10 mm	54 to 208 mm/s
Scan direction	Not specified	The scan direction will be detected, and data will be output from left to right.

# Dimensions

(Unit: mm)

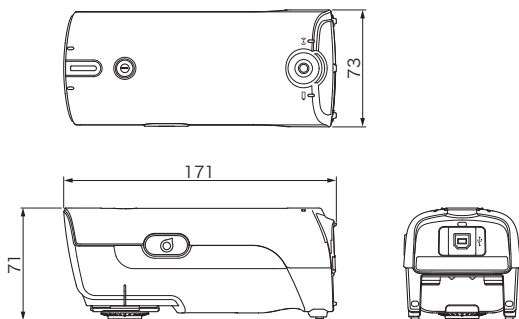

**< CAUTION >**

- **THE MANUFACTURER OF THIS PRODUCT WILL NOT BE LIABLE FOR ANY DAMAGES RESULTING FROM THE MISUSE, MISHANDLING, UNAUTHORIZED MODIFICATION, ETC. OF THIS PRODUCT, OR FOR ANY INDIRECT OR INCIDENTAL DAMAGES (INCLUDING BUT NOT LIMITED TO LOSS OF BUSINESS PROFITS, INTERRUPTION OF BUSINESS, ETC.) DUE TO THE USE OF OR INABILITY TO USE THIS PRODUCT.**



MYIRO